

BERTRAMS

TRAGETASCHEN & WERBEMITTEL

Etiketten Formen - PERFORATION - - ABRISS -

Bertrams Tragetaschen & Werbemittel
Inh. Sonja Bertrams
Hauptstraße 194
D - 26810 Westoverledingen

Telefon +49 (0) 4961-75607
info@bertrams-tragetaschen.de



Serie P

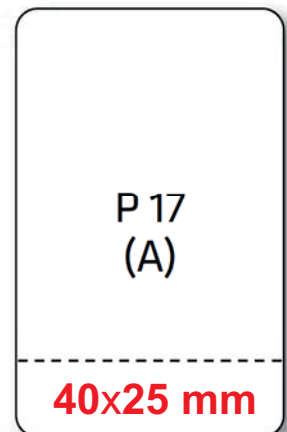
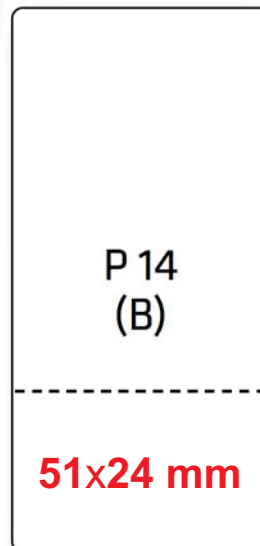
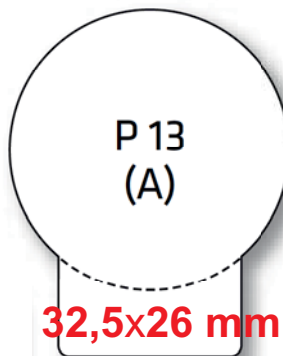
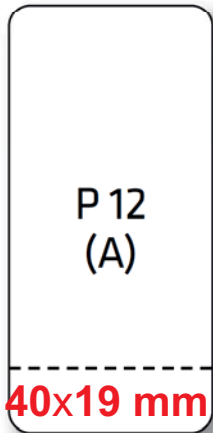
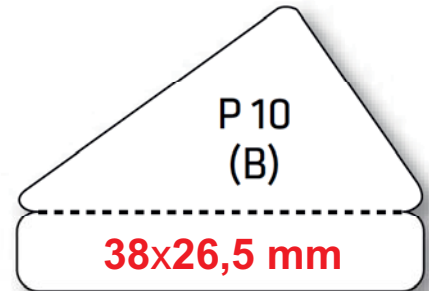
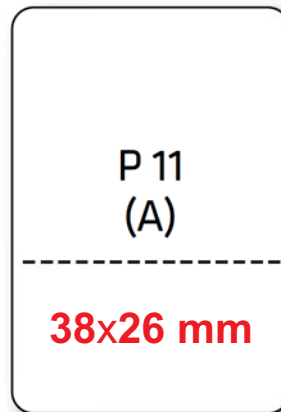
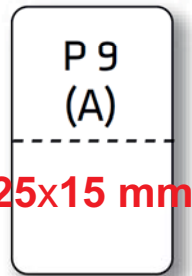
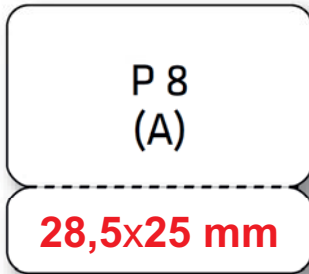
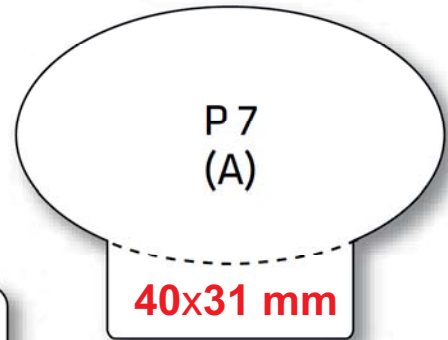
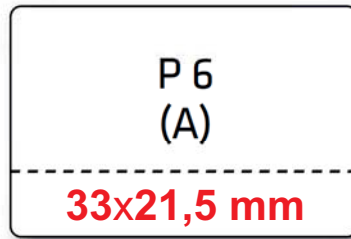
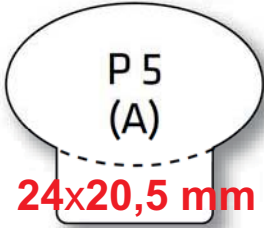
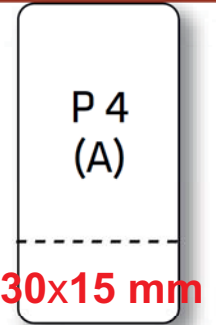
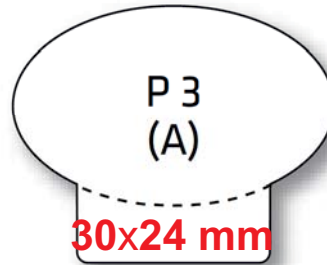
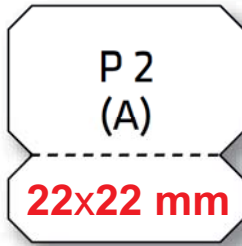
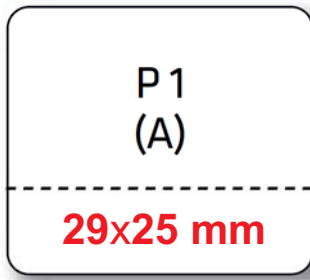

Serie P

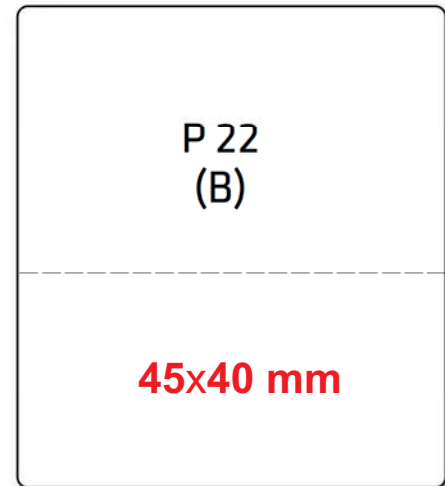
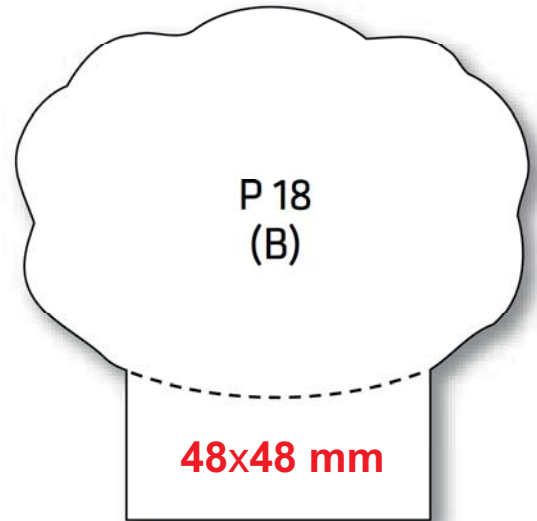
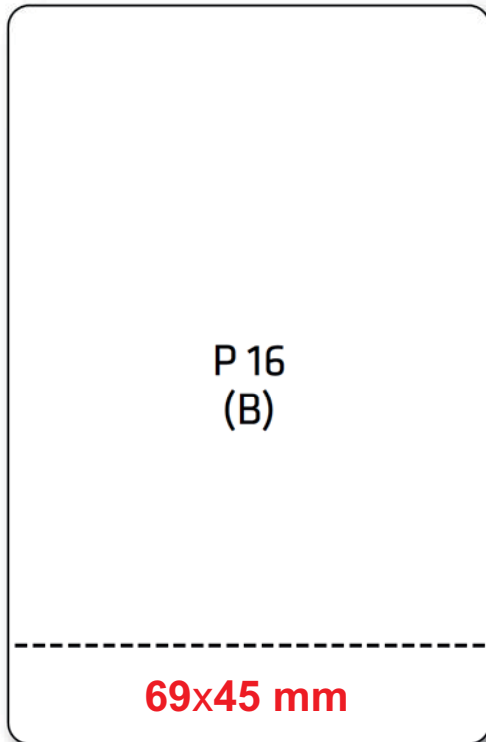

Serie P

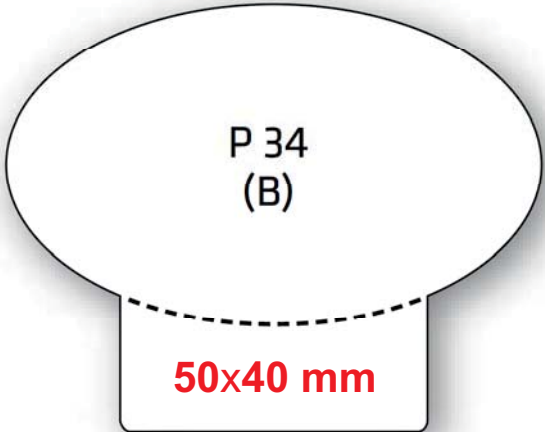
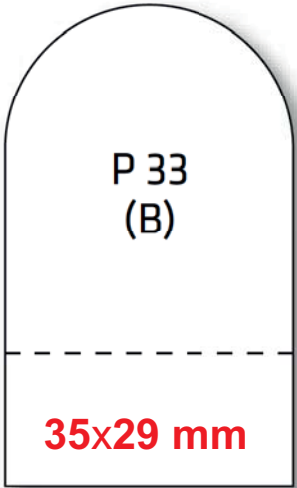
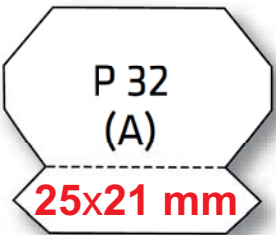
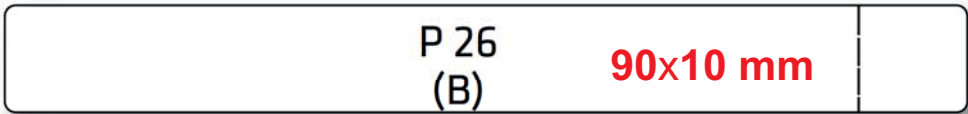
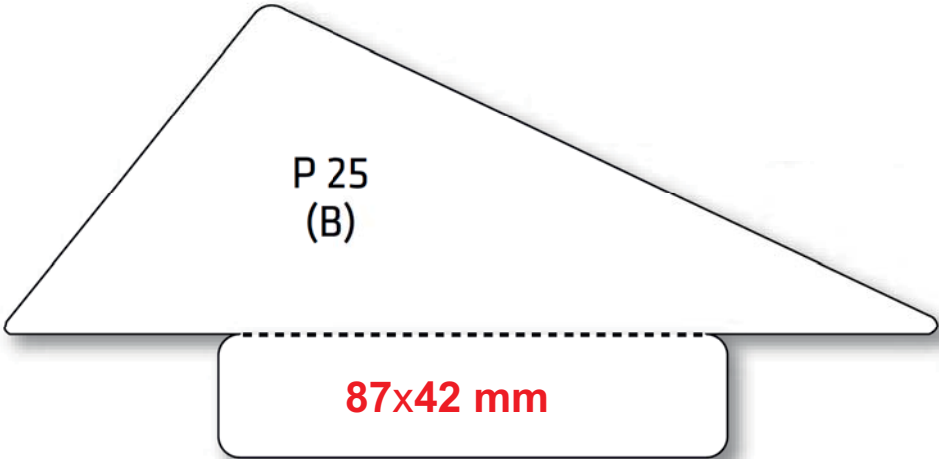

Serie P

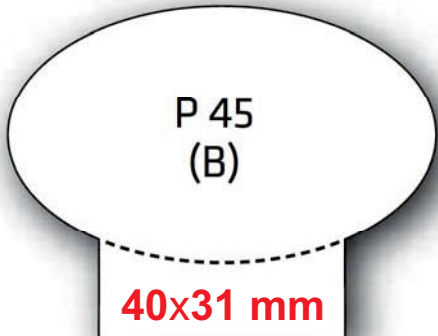
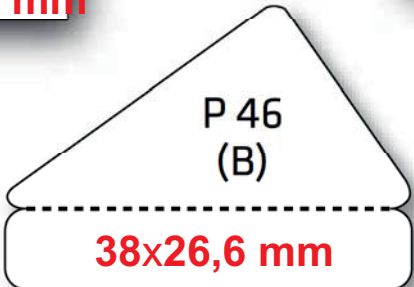
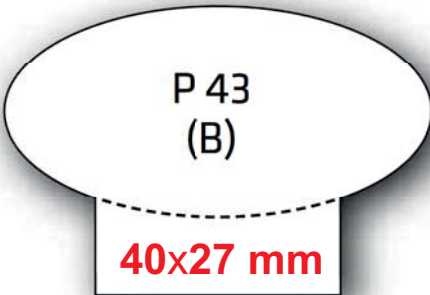
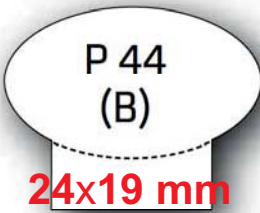
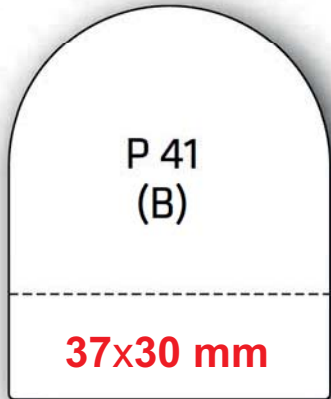
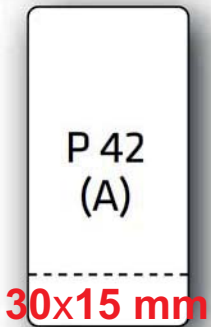
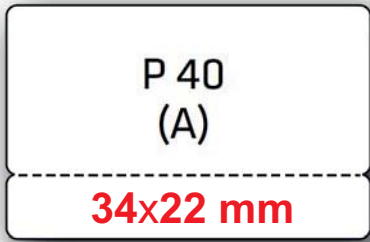
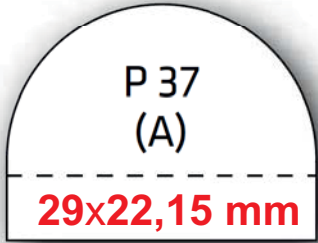
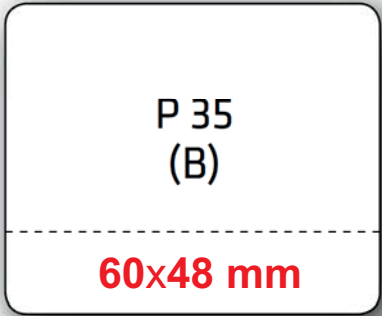

Serie P

