

BERTRAMS

TRAGETASCHEN & WERBEMITTEL

Etiketten Formen - DREIECK -

Bertrams Tragetaschen & Werbemittel
Inh. Sonja Bertrams
Hauptstraße 194
D - 26810 Westoverledingen

Telefon +49 (0) 4961-75607
info@bertrams-tragetaschen.de



Serie D

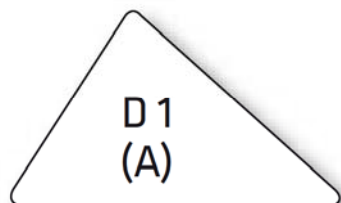

31x18 mm

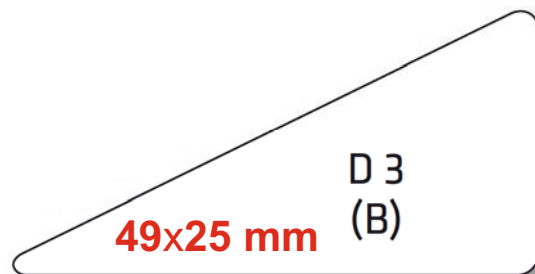

49x25 mm

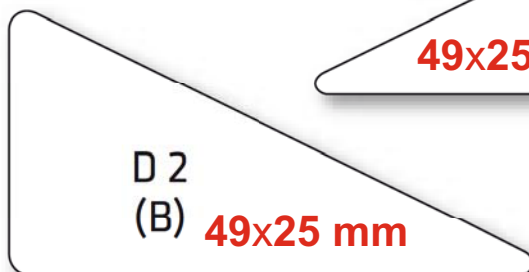

49x25 mm

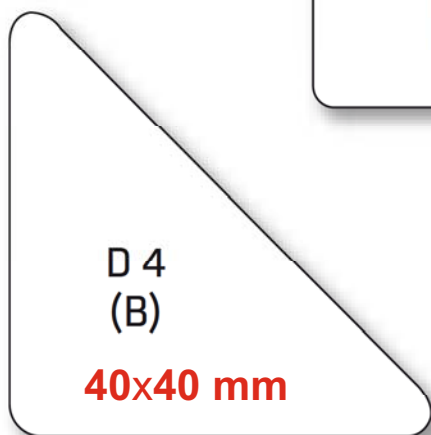

40x40 mm

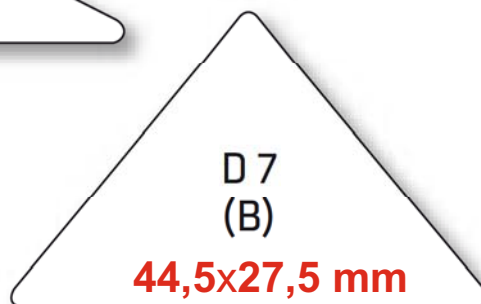

44,5x27,5 mm

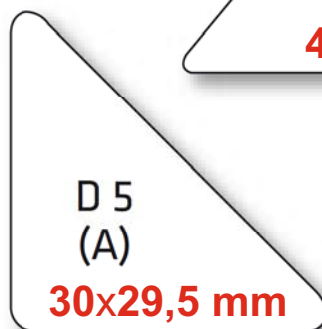

30x29,5 mm

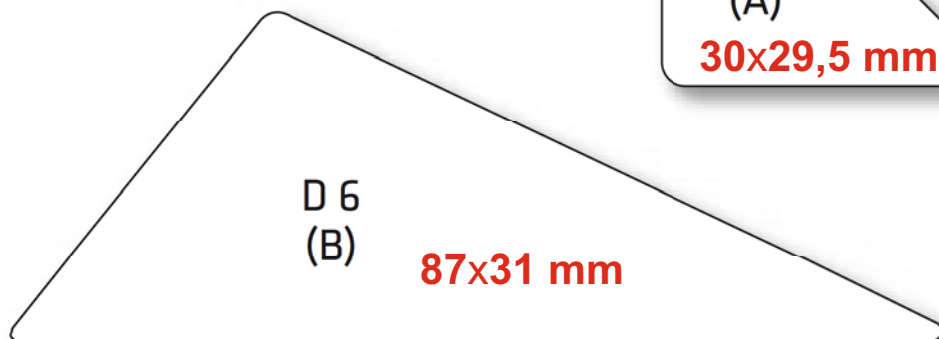

87x31 mm

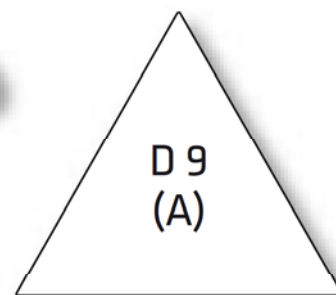

30,5x26,5 mm

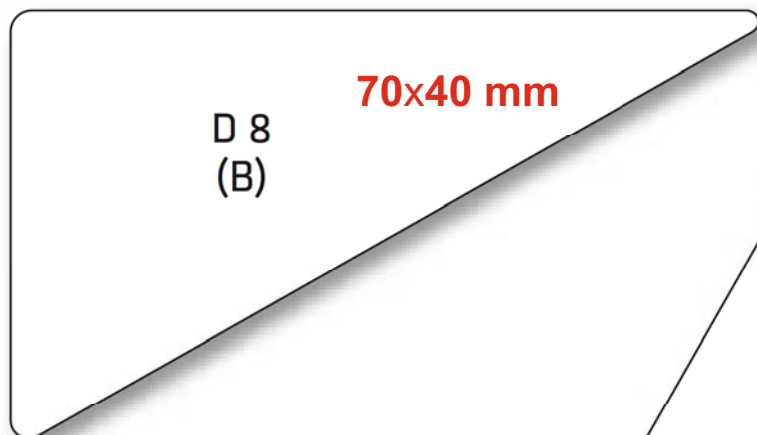

70x40 mm

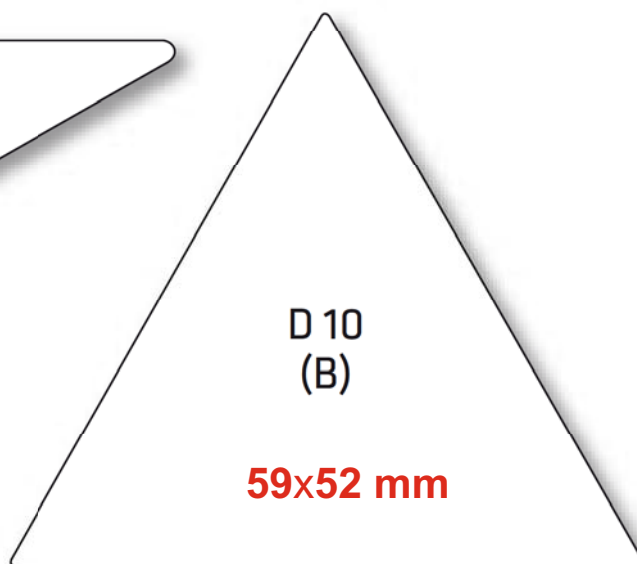

59x52 mm

Serie D

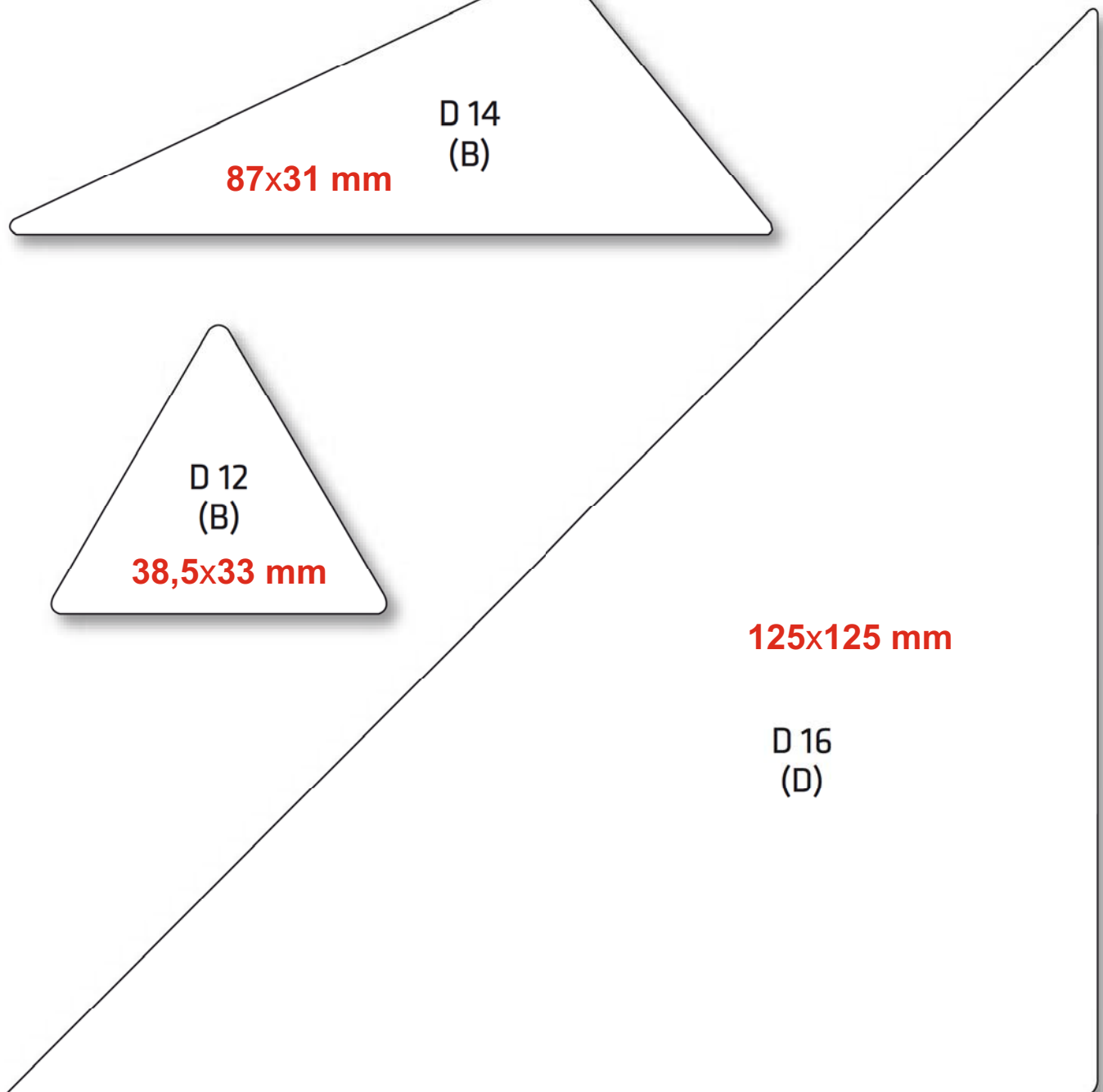
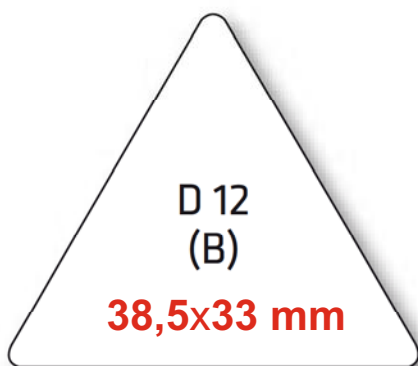
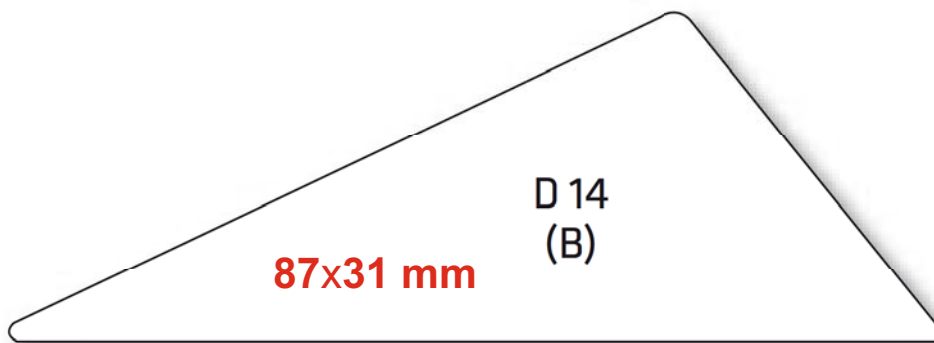
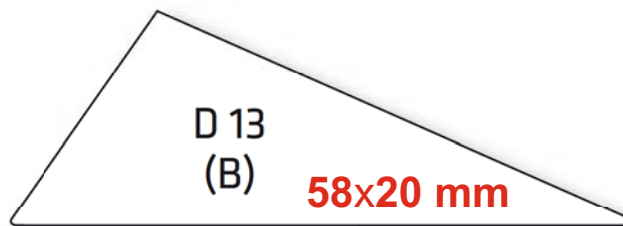
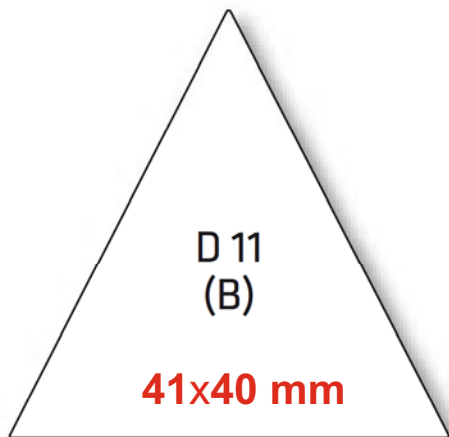

Serie D

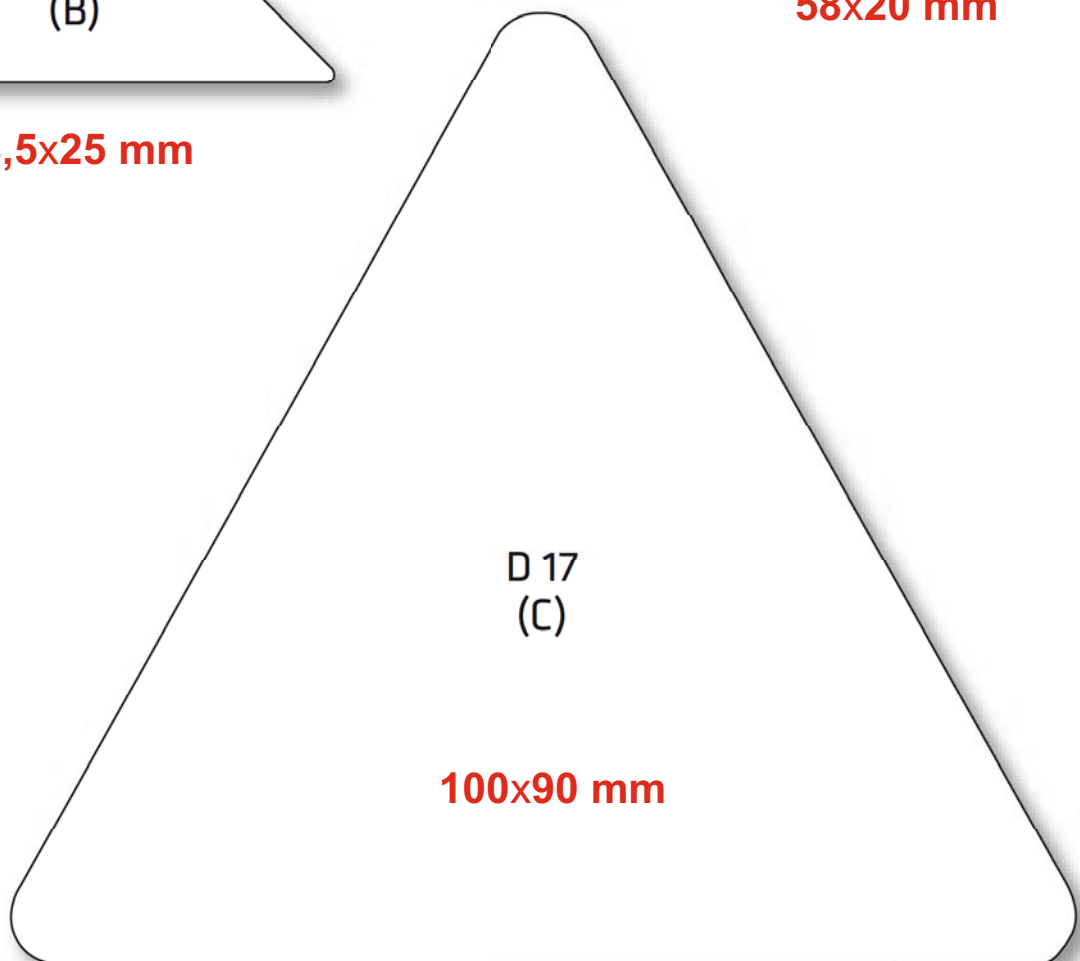
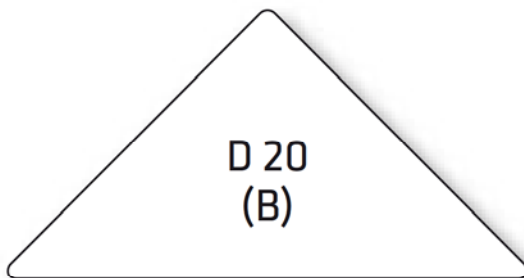
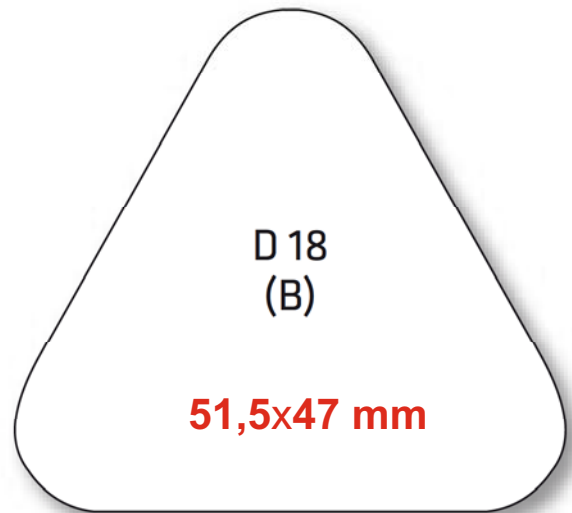
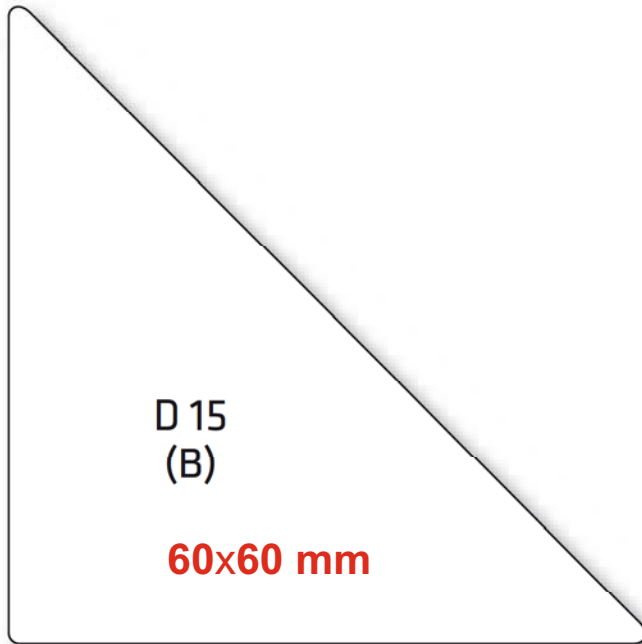

Serie D

85x55 mm

D 23
(C)

D 22
(C)

79x59 mm

D 21
(C)

118x104 mm

Serie D

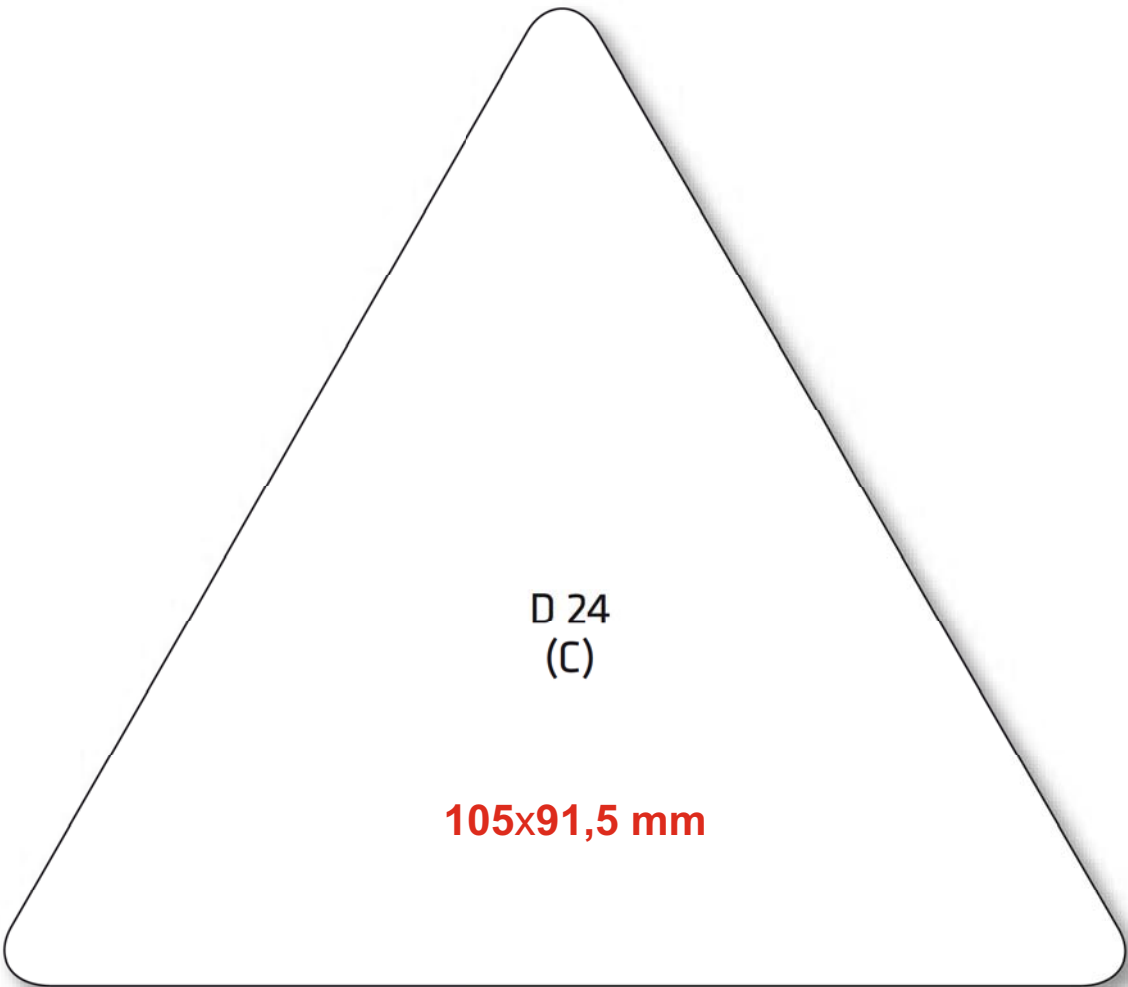

D 24
(C)

105x91,5 mm

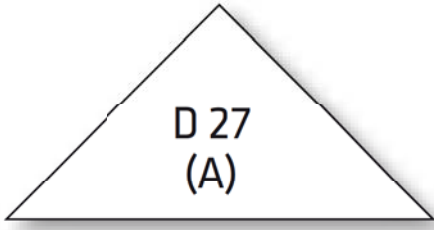

D 27
(A)

40x20 mm

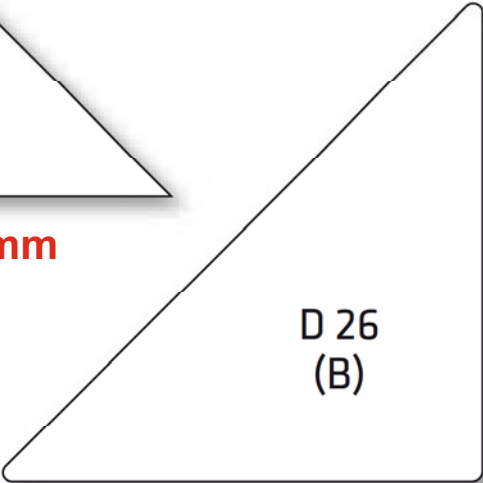

D 26
(B)

45x45 mm

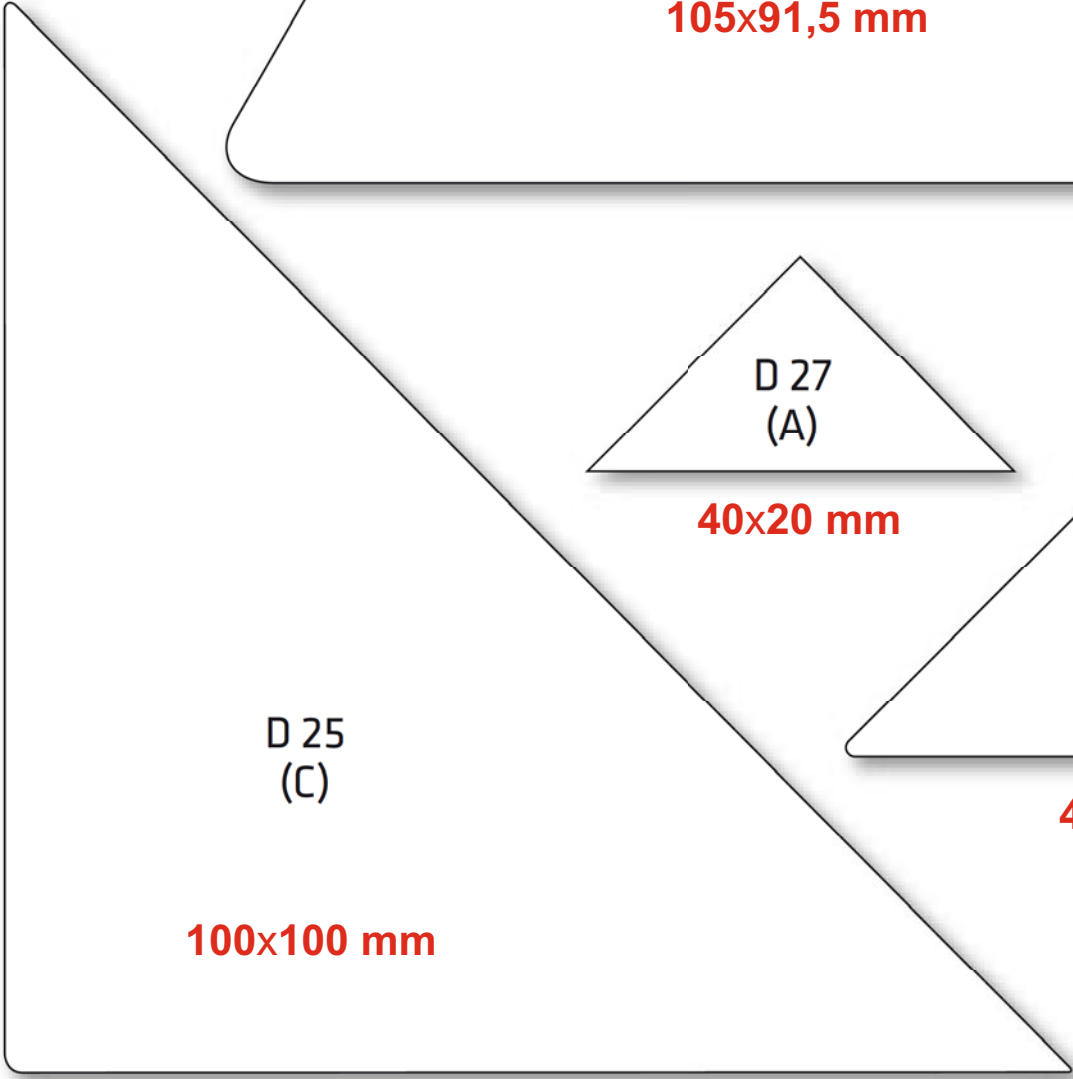

D 25
(C)

100x100 mm

Serie D

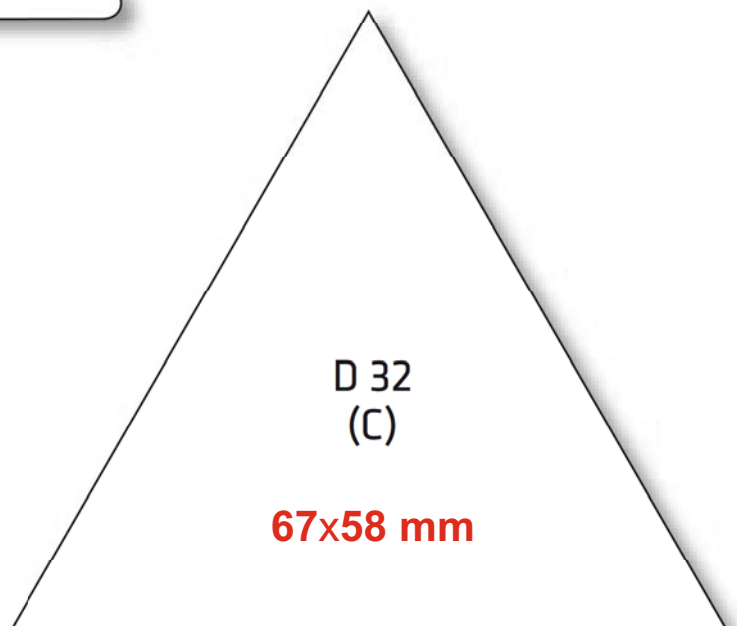
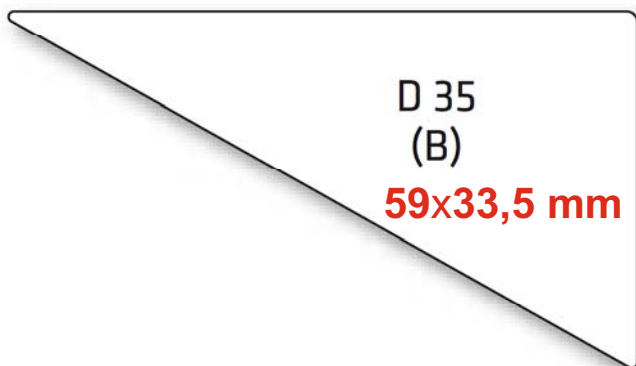
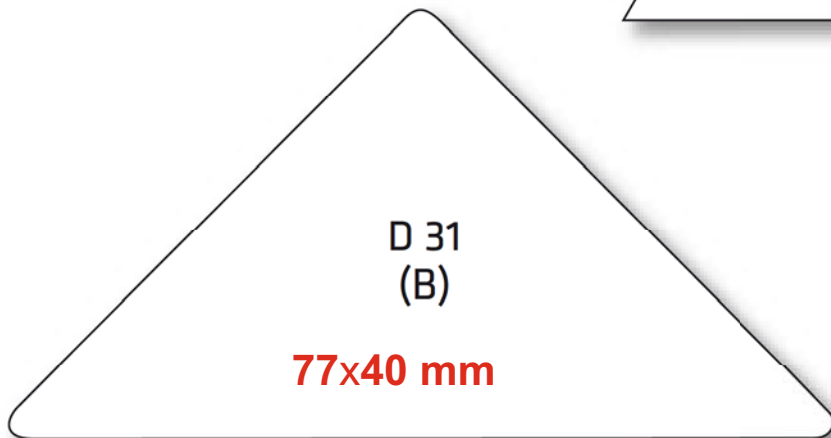
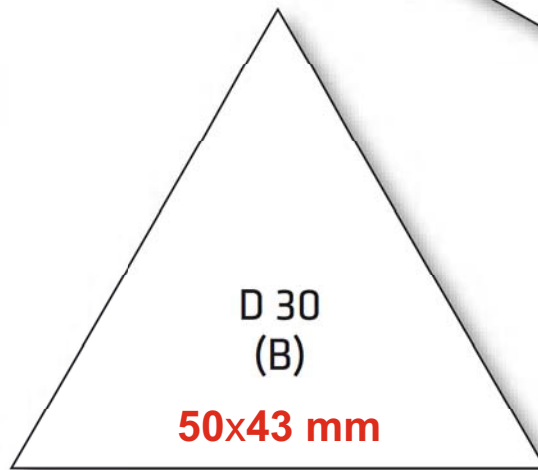
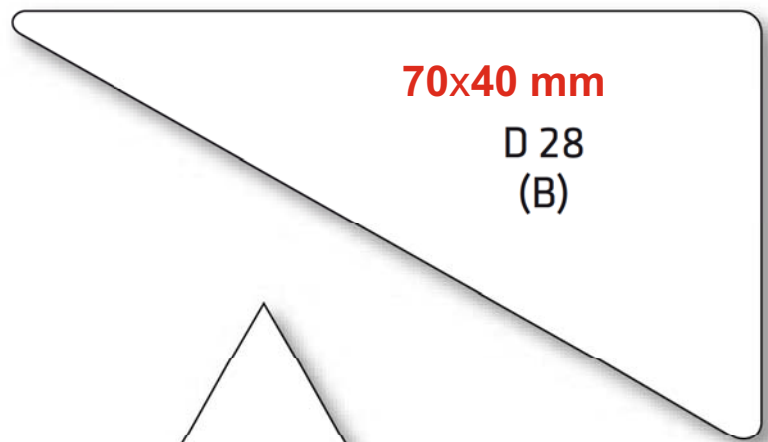
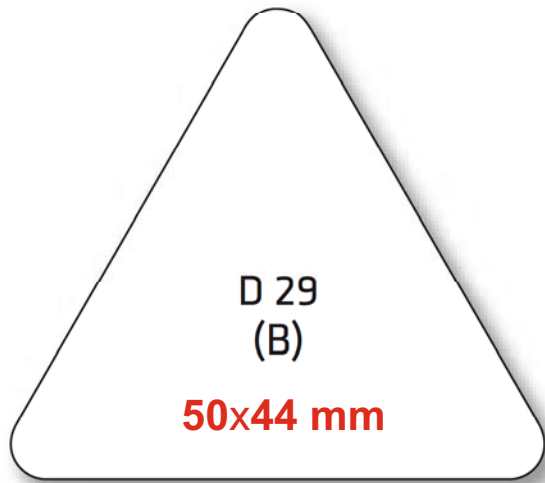

Serie D

