

BERTRAMS

TRAGETASCHEN & WERBEMITTEL

Etiketten

Diese exklusiven, individuell bedruckten Etiketten erstellen wir aus den unterschiedlichsten Formen, Papierfarben und Druckfarben. Dieses für Sie exklusiv bedruckte selbstklebende Etikett liefern wir je nach Auflage auf Rollen mit 1.000, 1.250 oder 2.500 Stück gewickelt. Schon ab 1.000 Stück mit einem Heißfoliendruck produzierbar.



INDEX

- Seite 2 - Preisliste Stand 03/2021 - [gültig bis auf Widerruf]
- Seite 3-13 - Entsprechende Stanz-Formen für die Preisgruppen A / B / C / D
- Seite 14 - Papier Farben Sortiment
- Seite 15 - Heißfoliendruckfarben Sortiment

ETIKETTEN PREISLISTE

Preise für Etiketten mit oder ohne Druck
(Preise netto pro tausend Stück) Stand 03 / 2021

Entsprechende Stanz-Formen ohne Aufpreis für die Preisgruppen A / B / C / D - Seite 3 bis 13

bei Abnahme	Druck	Preisgruppen			
		A	B	C	D
1.000 Stück	1-farbig	78,70 €	86,50 €	111,30 €	154,00 €
	2-farbig	94,50 €	103,70 €	133,50 €	184,80 €
	unbedruckt	66,90 €	73,50 €	94,60 €	130,90 €
2.500 Stück	1-farbig	39,80 €	46,10 €	69,40 €	87,40 €
	2-farbig	47,80 €	55,40 €	83,20 €	104,80 €
	3-farbig	57,30 €	66,40 €	99,90 €	125,80 €
	unbedruckt	33,90 €	39,20 €	59,00 €	74,30 €
5.000 Stück	1-farbig	30,60 €	34,30 €	60,30 €	75,30 €
	2-farbig	36,70 €	41,10 €	72,30 €	90,40 €
	3-farbig	44,00 €	49,30 €	86,80 €	108,50 €
	unbedruckt	26,00 €	29,10 €	51,30 €	64,00 €
10.000 Stück	1-farbig	22,90 €	25,10 €	49,70 €	66,40 €
	2-farbig	27,50 €	30,20 €	59,60 €	79,60 €
	3-farbig	33,00 €	36,20 €	71,50 €	95,60 €
	unbedruckt	19,50 €	21,40 €	42,20 €	56,40 €
15.000 Stück	1-farbig	19,45 €	21,45 €	42,00 €	56,35 €
	2-farbig	23,35 €	25,70 €	50,45 €	67,65 €
	3-farbig	28,00 €	30,90 €	60,60 €	81,20 €
	unbedruckt	16,60 €	18,20 €	35,70 €	47,90 €
20.000 Stück	1-farbig	17,45 €	19,55 €	38,85 €	50,70 €
	2-farbig	20,95 €	23,45 €	46,60 €	60,85 €
	3-farbig	25,20 €	28,20 €	37,30 €	73,00 €
	unbedruckt	14,90 €	16,60 €	33,00 €	43,10 €

Nebenkosten:

- zzgl. Prägestempel pro Farbe á 35,00 € (entfällt bei unverändertem Druck)
- Motiv- oder Farbwechsel innerhalb des Auftrags á 15,00 €
- Bei Erstauftrag ist die Lieferung an 1 Adresse innerhalb der BRD ohne Versandkosten.

- Alle Preise verstehen sich netto zzgl. der gesetzlichen Mehrwertsteuer !



1 handlicher Spenderkarton
je Motiv wird kostenlos
mitgeliefert

RECHTECKIGE ETIKETTEN MIT ABGERUNDETEN ECKEN



(Breite x Höhe in mm)

Preisgruppen

A	A	B	B	C	C	C	D
10x10	35x10	40x25	58x35	60x60	85x25	100x50	120x90
12x5	35x15	40x30	60x15	65x35	85x40	100x55	120x100
15x10	35x17	40x35	60x20	65x40	85x50	100x60	120x120
15x15	35x20	40x40	60x25	65x50	85x60	100x70	140x100
18x10	35x25	45x20	60x30	65x60	86x45	100x80	145x70
20x5	35x30	45x25	60x35	70x20	90x15	100x100	145x80
20x10	35x35	45x30	60x40	70x25	90x20	105x55	145x90
20x15	36x25	45x35	60x45	70x34	90x30	105x75	145x100
20x20	36x30	45x40	60x50	70x42	90x35	109x50	145x110
25x10	40x5	45x45	60x55	70x50	90x40	115x60	145x120
25x15	40x10	48x32	65x10	70x70	90x50	115x75	145x130
25x20	40x15	49x38	65x15	75x20	90x60	120x35	145x145
25x25	40x20	50x20	65x17	75x25	90x70	120x50	
26x6	44x12	50x25	65x20	75x30	90x80	120x55	
27x17	45x5	50x30	65x25	75x35	90x90	120x60	
30x4	45x10	50x35	65x30	75x40	95x15	120x80	
30x5	45x15	50x40	68x22	75x50	95x20	125x25	
30x10	50x5	50x45	70x15	75x55	95x25	125x75	
30x15	50x10	50x50	70x30	80x20	95x40	130x30	
30x20	50x15	53x42	75x10	80x25	95x45	130x40	
30x30	52x15	55x15	80x15	80x30	95x50	130x50	
32x11	55x10	55x20	85x6	80x35	95x65	130x60	
33x23	60x10	55x30	85x15	80x40	95x80	130x70	
35x5		55x35	90x10	80x45	95x95	130x80	
35x8		55x40	95x10	80x50	100x25	140x35	
		55x45	105x30	80x60	100x34	145x30	
		55x50	115x15	80x65	100x40	145x40	
		56x21	145x10	80x70	100x45	145x50	
		56x27	145x20	80x80		145x60	

RECHTECKIGE ETIKETTEN MIT SPITZEN ECKEN

(Breite x Höhe in mm)

Preisgruppen

A	A	B	B	C	D
12x5	30x20	37x34	85x15	70x60	118x88
18x18	40x17	50x25	90x10	80x60	
22x22	44x12	50x50	90x20	100x60	
22x38	44x20	65x25	145x10		
25x20	50x20	70x30	145x20		
25x25	60x20	80x20			

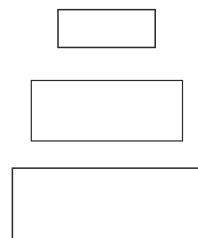

RECHTECKIGE ETIKETTEN MIT ABGERUNDETEN ECKEN

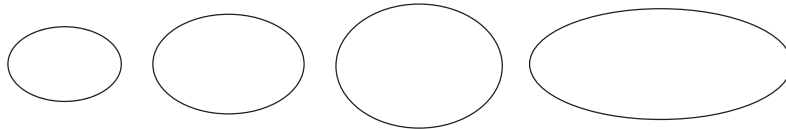

(Breite x Höhe in mm)

Preisgruppen

A	B	B	C	C	D
15x10	40x25	60x25	60x40	100x45	140x80
20x15	40x30	60x30	60x45	100x50	140x90
25x10	45x25	60x31	70x25	105x75	
25x15	45x27	60x33	70x30	110x80	
27x20	45x30	61x33	70x40	115x90	
30x10	45x32	100x25	70x45	120x80	
30x15	45x35		75x50	140x50	
30x20	48x30		79x34	140x70	
31x21	50x20		80x40		
31x23	50x25		85x55		
32x21	50x30		85x60		
35x15	50x35		90x50		
35x20	50x38		90x60		
35x25	55x25		95x35		
37x23	55x30		95x45		
37x25	55x35		95x70		
40x15	55x39		95x75		
40x20	57x18		100x34		
45x16	58x41		100x43		

RUNDE ETIKETTEN

(Breite x Höhe in mm)

Preisgruppen

A	A	B	C	D
8	20	35	60	110
10	22	38	70	120
12	25	40	80	145
13	26	42	90	
15	28	45	95	
16	30	50		
17	32	55		
18		58		

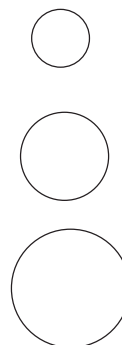

ETIKETTEN – MIT LEIMFREIEN ABRISS in Originalgrößen - Abriss perforiert

Werbung dank Etiketten mit leimfreien Preisabriss

Der Vorteil: Lediglich der Preisabriss wird entfernt, nicht das komplette Etikett mitsamt Werbedruck.

Bitte beachten! Herstellung nur mit weißem Grundpapier „weiss glanz Nr. 051“ - preisabriss leimfrei- möglich.

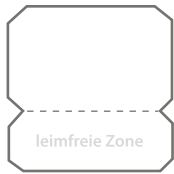

Art.-Nr. 80327 A
22 x 22 mm

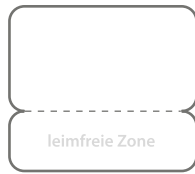

Art.-Nr. 80372 A
25 x 22 mm

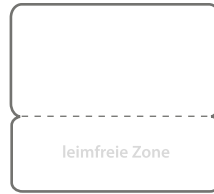

Art.-Nr. 80365 A
28 x 25 mm



Art.-Nr. 80362 A
34 x 22 mm

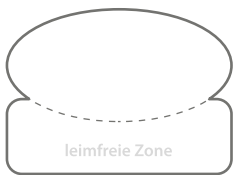

80376 A
30 x 22 mm

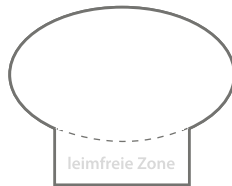

80326 A
30 x 24 mm

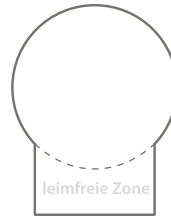

80329 A
22 x 28 mm

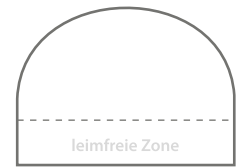

80368 A
29 x 21 mm

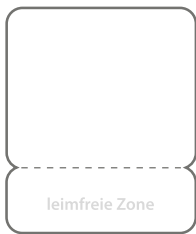

80579 A
25 x 30 mm

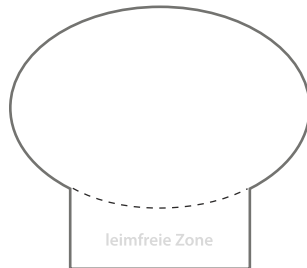

80331 B
40 x 35 mm

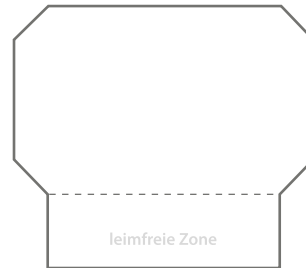

80328 B
40 x 35 mm

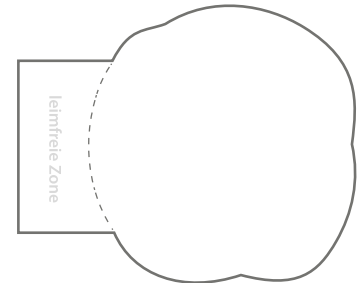

80497 B
37 x 45 mm



80490 A
50 x 15 mm



80499 A
61 x 11 mm



80330 B
45 x 35 mm

SONDERFORMEN IN ORIGINALGRÖÖE - PREISGRUPPE A

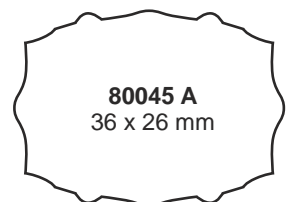
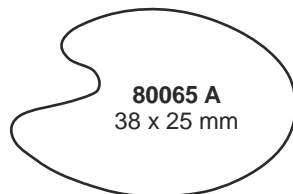
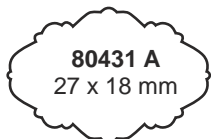
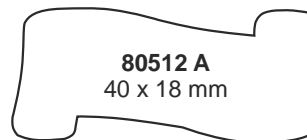
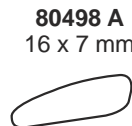
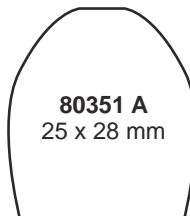
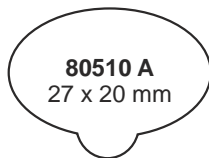
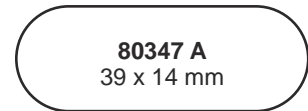
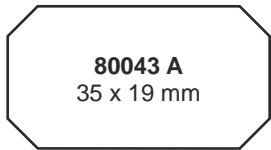
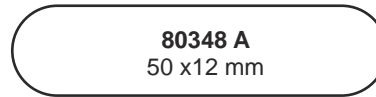
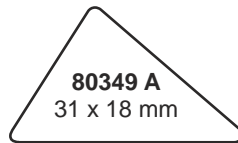
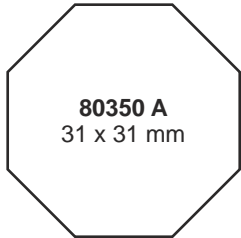
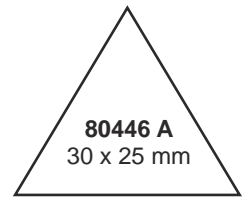
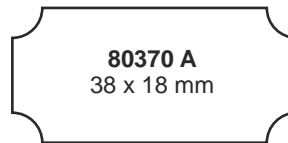
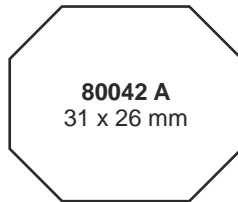
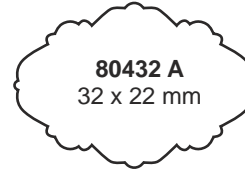
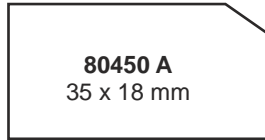
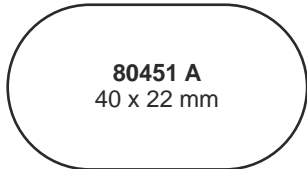
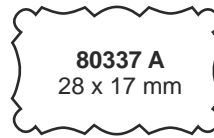
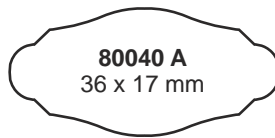
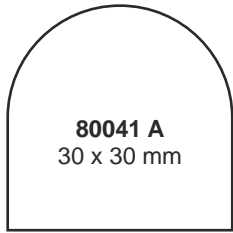

SONDERFORMEN IN ORIGINALGRÖÖE - PREISGRUPPE A

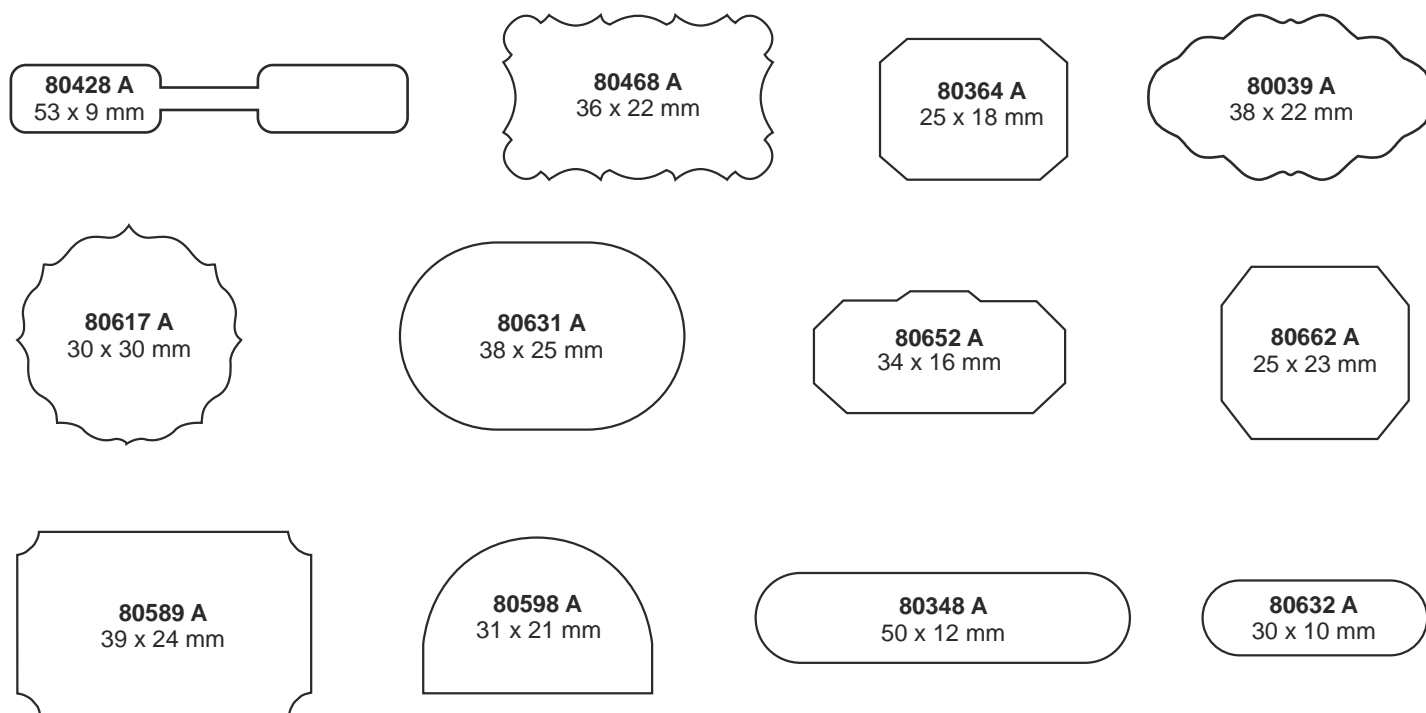

SONDERFORMEN IN ORIGINALGRÖÖE - PREISGRUPPE B

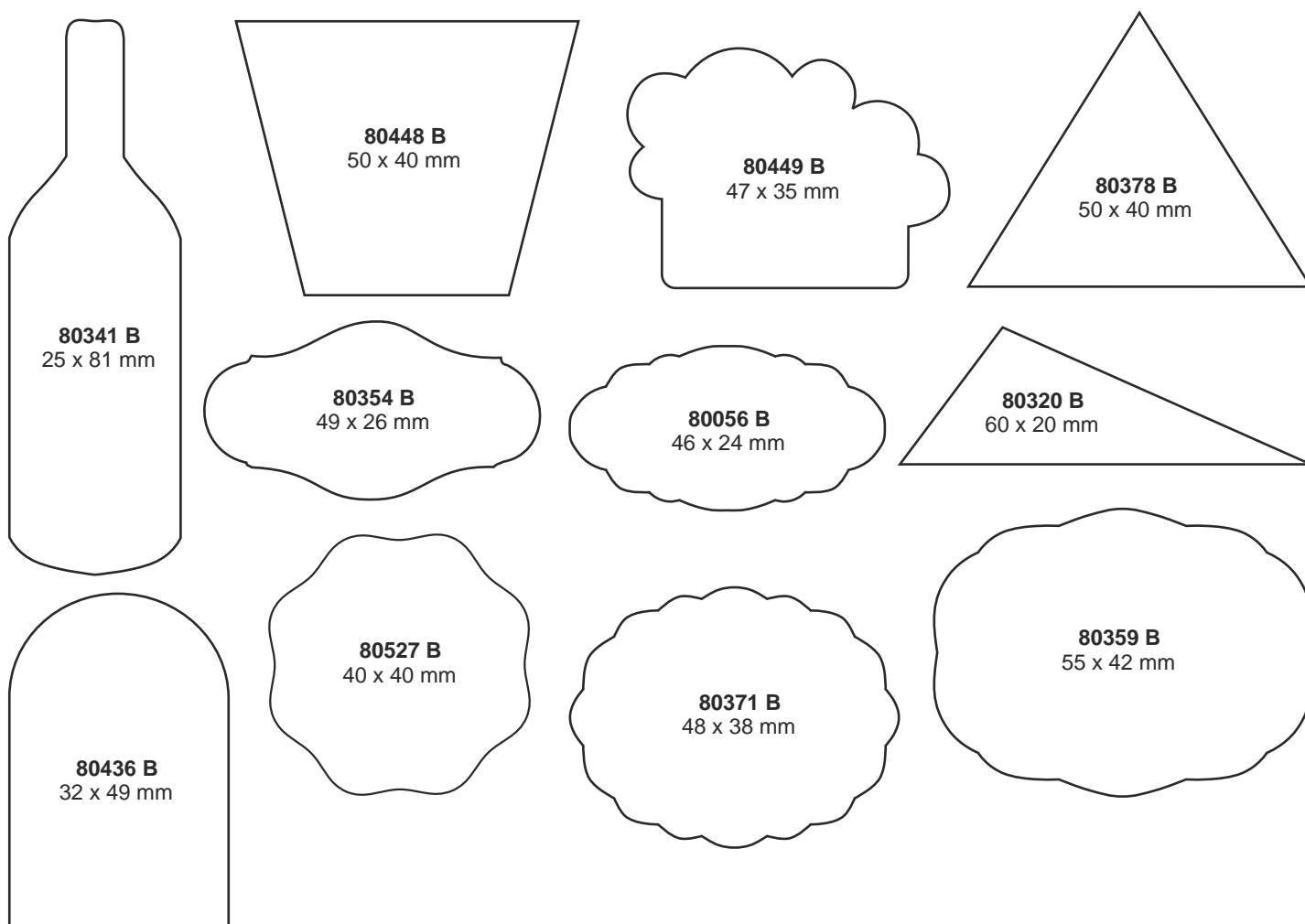

SONDERFORMEN IN ORIGINALGRÖÖE - PREISGRUPPE B

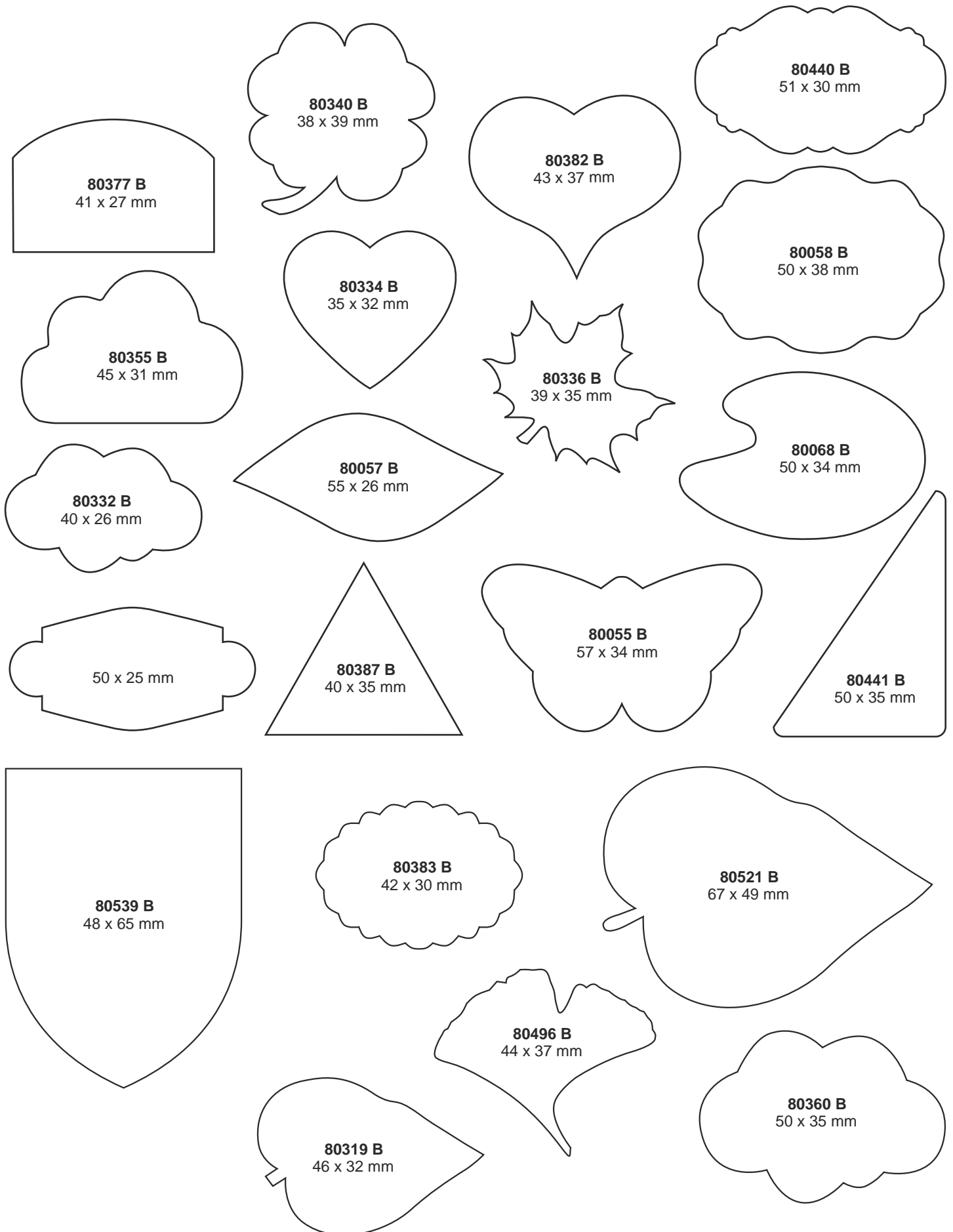

SONDERFORMEN IN ORIGINALGRÖÖE - PREISGRUPPE B

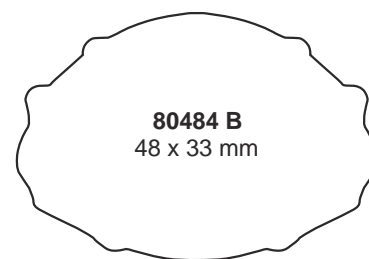
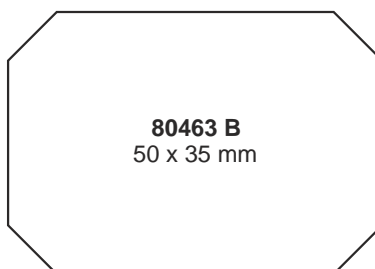
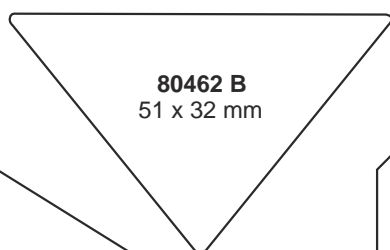
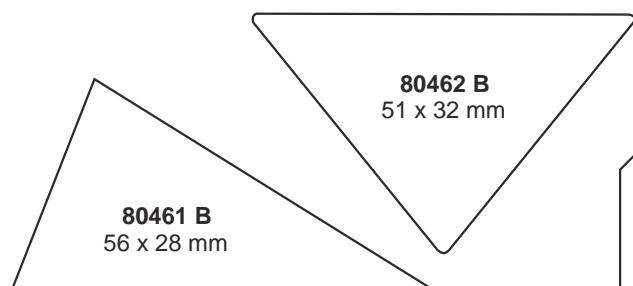
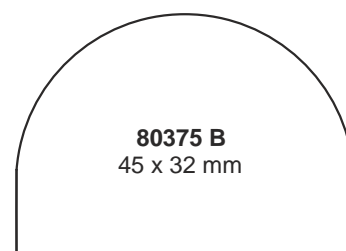
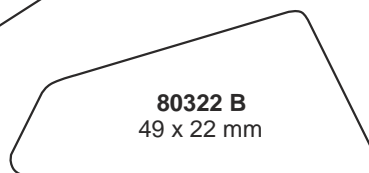
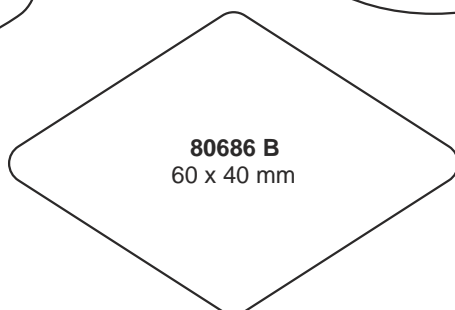
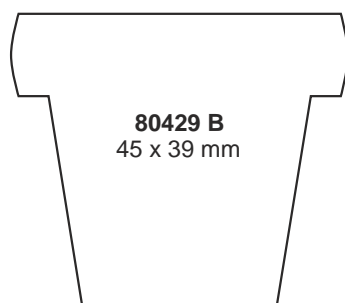
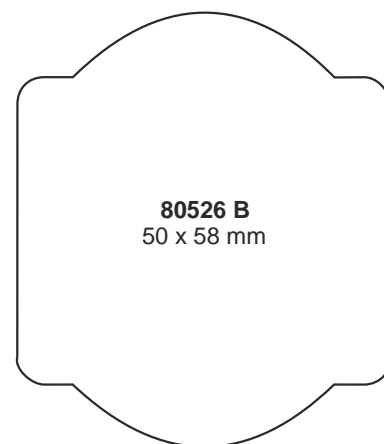
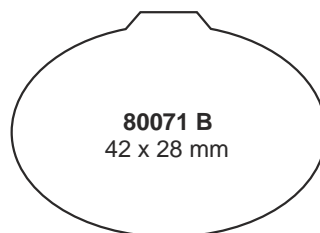
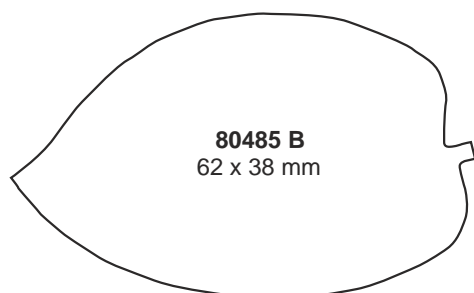
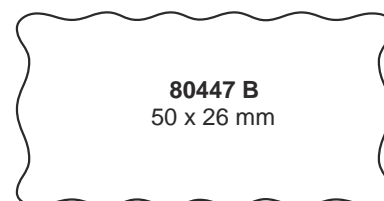
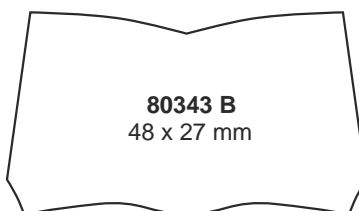
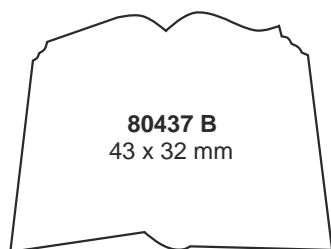
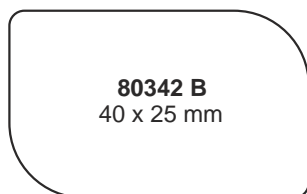
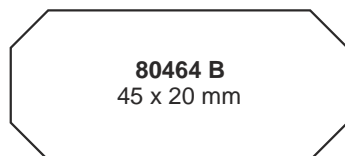

SONDERFORMEN IN ORIGINALGRÖÖE - PREISGRUPPE B

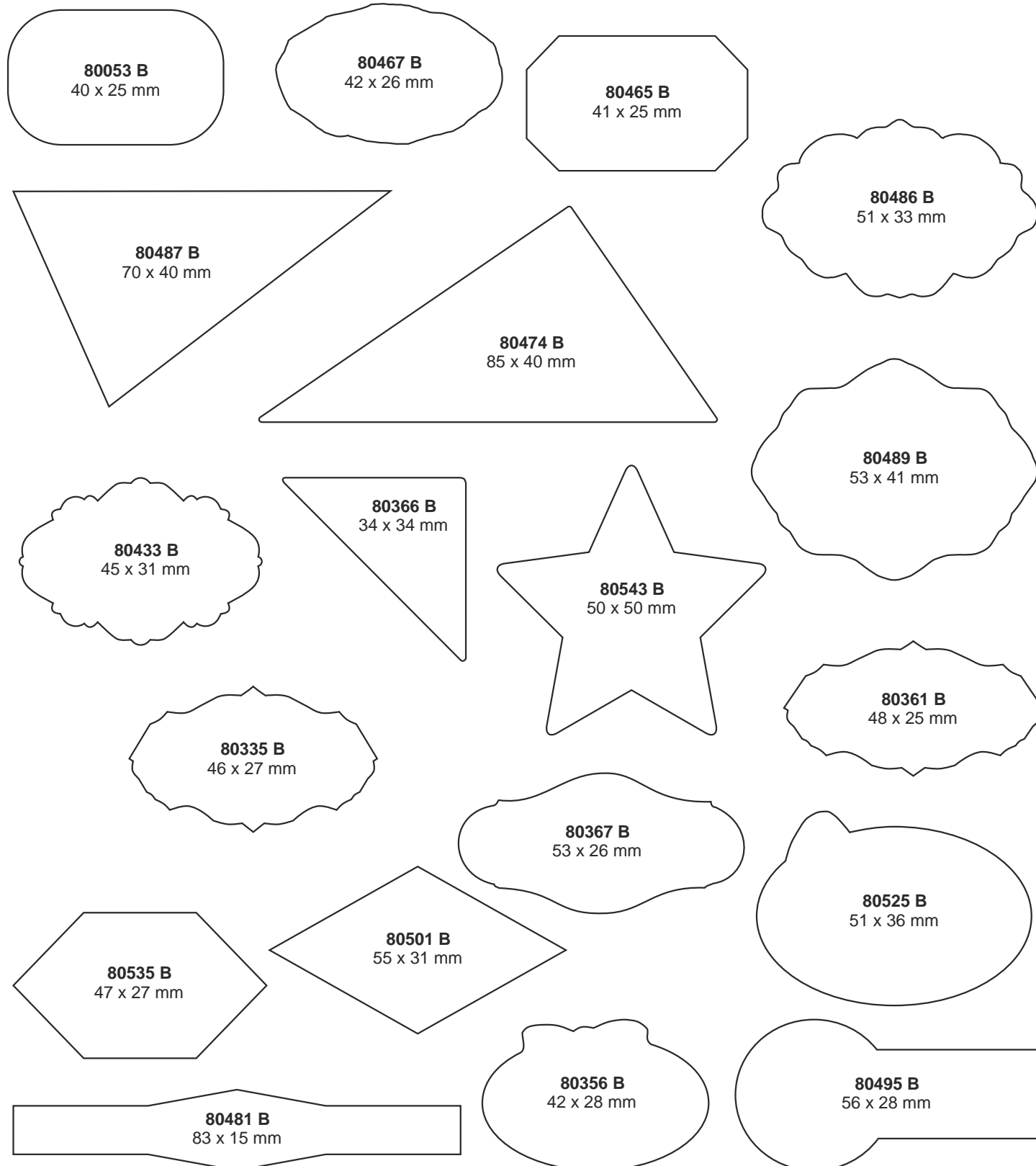

SONDERFORMEN IN ORIGINALGRÖÖE - PREISGRUPPE B

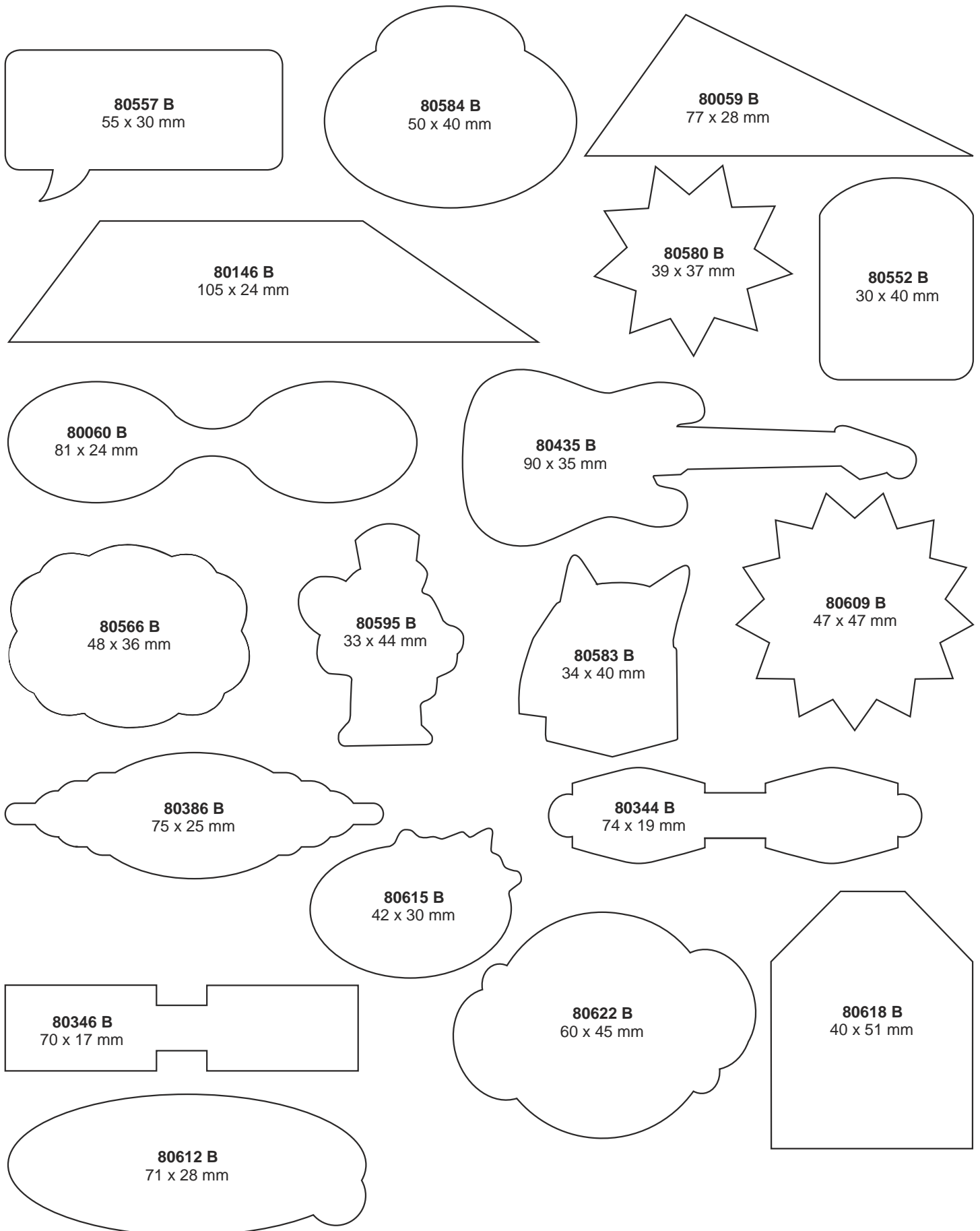

SONDERFORMEN IN ORIGINALGRÖÖE - PREISGRUPPE B

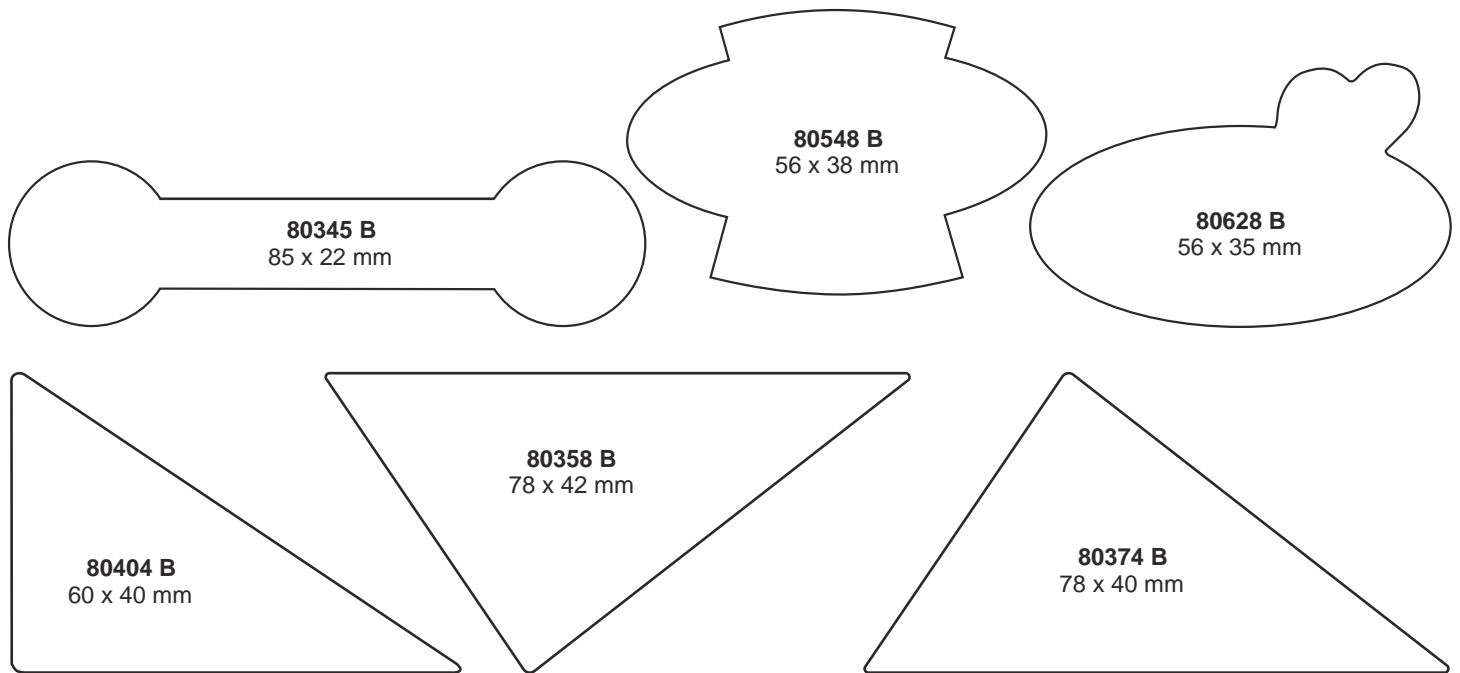

SONDERFORMEN IN ORIGINALGRÖÖE - PREISGRUPPE C

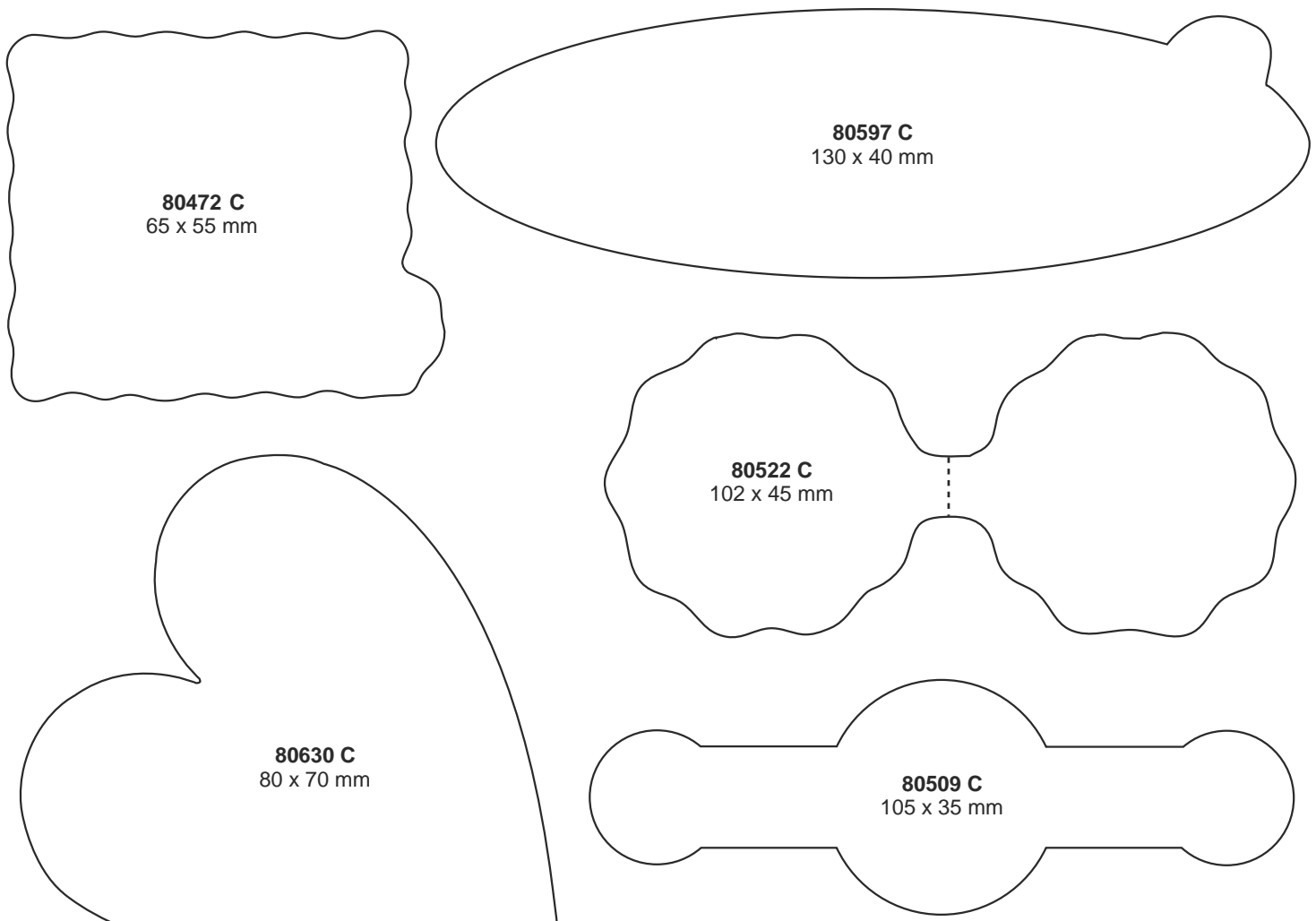

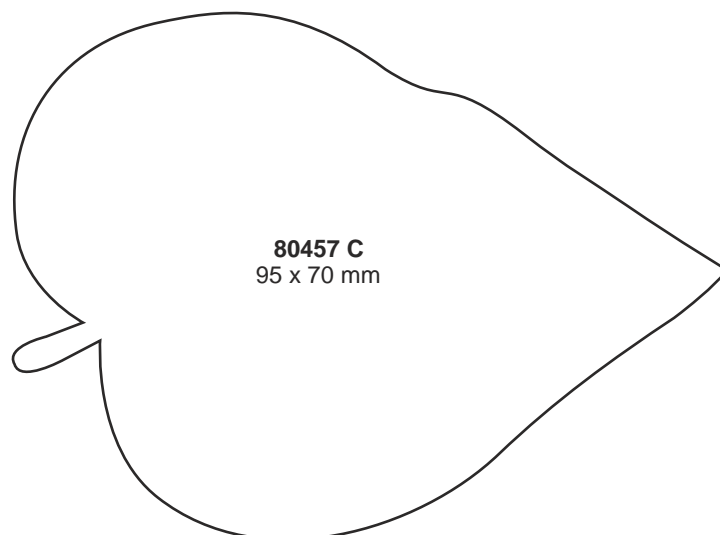
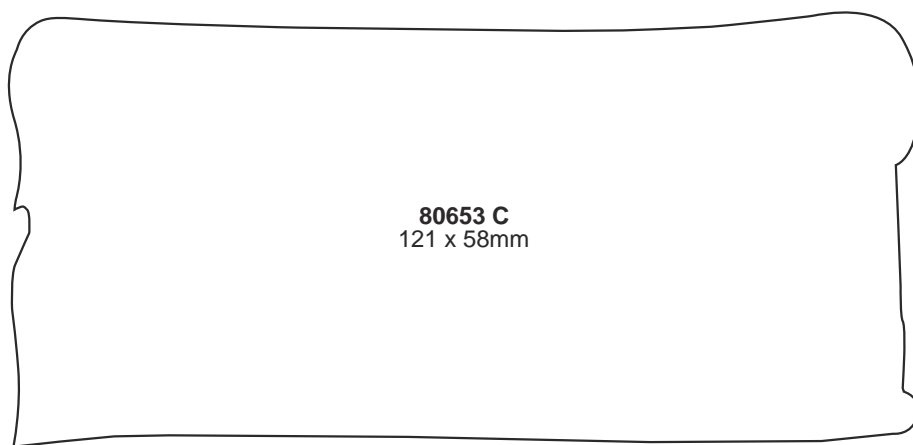
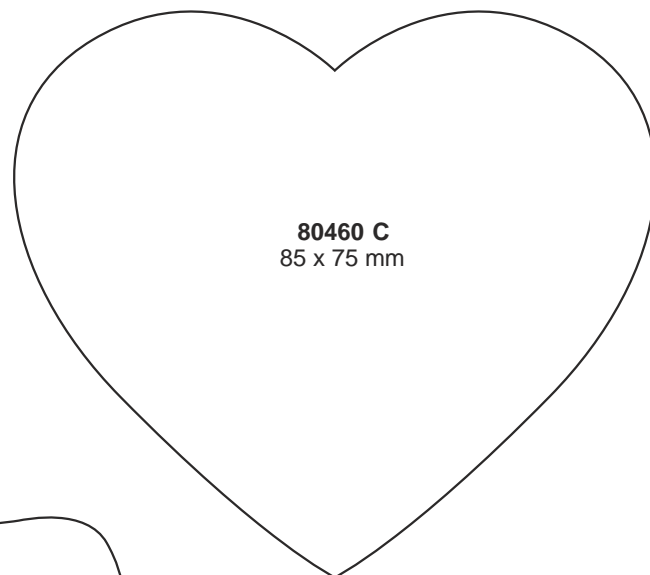
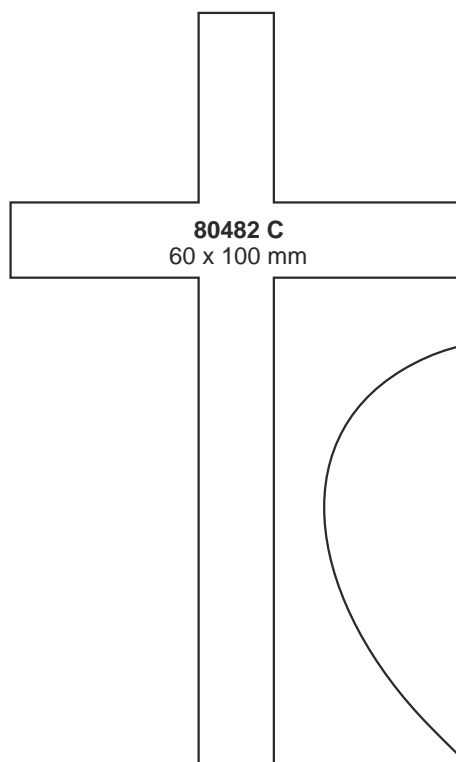
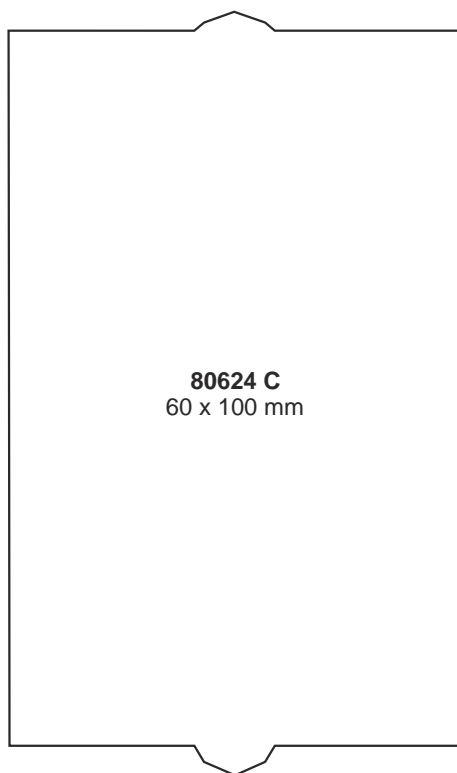

Die Darstellung der Papierfarben ist nicht verbindlich

Papiersorten - matt



Papiersorten - glänzend

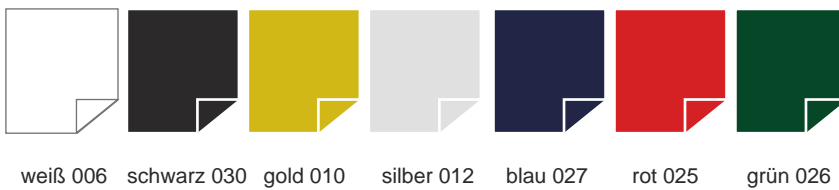

Fluorpapiere - matt

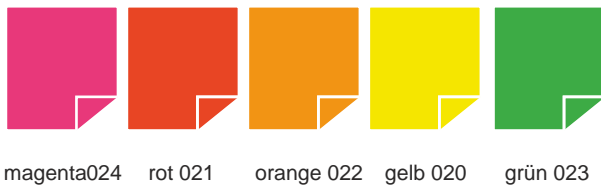

Kraftpapiere - matt



Sonderpapiere



Polyäthylen

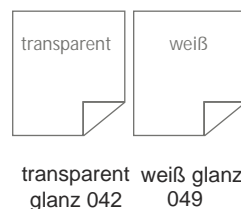

Die Darstellung der Druckfarben ist nicht verbindlich

Druckfarben - Vollton



weiß 601



schwarz 602



gold matt 603



silber matt 604



anthrazit 605



grau 606



hellgrau 607



lila 608



dunkelblau 609



blau 610



blau 611



blau 612



blau 613



hellblau 631



dunkelgrün 614



grün 615



grün 616



grün 617



oliv 618



hellgrün 633



rot 632



rot 619



rot 620



rotorange 621



orange 622



pink 623



bordeaux 624



zitronengelb 625



sonnengelb 626



creme 627



karamel 628



braun 629



dunkelbraun 634

Druckfarben metallic



gold-M 770



kupfer-M 771



silber-M 772



rot-M 773



pink-M 774



blau-M 775



grün-M 776



türkis-M 777



regenbogen-M 778